



June 10, 2011

In Reply Refer To:  
HSST/B-212

Ms. Karla A. Lechtenberg, MSME, EIT  
Research Associate Engineer  
Midwest Roadside Safety Facility  
130 Whittier Research Center  
2200 Vine Street  
Lincoln, NE 68583-0853

Dear Ms. Lechtenberg:

This letter is in response to your request for the Federal Highway Administration (FHWA) acceptance of a roadside safety system for use on the National Highway System (NHS).

Name of system: Midwest Guardrail System  
Type of system: Steel Post and W-beam roadside barrier  
Test Level: AASHTO Manual for Assessing Safety Hardware  
Test Level 3  
Testing conducted by: Midwest Roadside Safety Facility  
Date of request: December 18, 2010  
Date initially acknowledged: December 18, 2010  
Task Force 13 Designator: SGR20 a-b

You requested that we find this system acceptable for use on the NHS under the provisions of the American Association of State Highway and Transportation Officials (AASHTO) "Manual for Assessing Safety Hardware" (MASH).

### **Requirements**

Roadside safety devices should meet the guidelines contained in the MASH.

### **Decision**

The following device was found acceptable, with details provided below:

- Midwest Longitudinal Guardrail System (MGS)

### **Description**

The test installation consisted of 55.25 meters (181 feet 3 inches) of standard 2.66 millimeters (12-gauge) thick W-beam guardrail supported by steel posts. Anchorage systems similar to those used on tangent guardrail terminals were utilized on both the upstream and downstream ends of



FHWA:HSST:WLongstreet:ms:x60087:6/1/11  
File: h://directory folder/HSST/ B212\_053111.docx  
cc: HSST Will Longstreet

the guardrail system. The entire system was constructed with twenty-nine guardrail posts. Post numbers 3 through 27 were galvanized ASTM A36 steel W152 x 13.4 (W6 x 9) sections measuring 1,829 millimeters (6 feet) long. Post numbers 1, 2, 28, and 29 were timber posts measuring 140 millimeters wide x 190 mm deep x 1,080 millimeters long (5.5-inch x 7.5-inch x 42.5-inch) and were placed in 1,829 millimeters (6 feet) long steel foundation tubes. The timber posts and foundation tubes were part of anchor systems designed to replicate the capacity of a tangent guardrail terminal. Post numbers 1 through 29 were spaced 1,905 millimeters (75 inches) on center with a soil embedment depth of 1,016 millimeters (40 inches). The posts were placed in a compacted coarse, crushed limestone material that met Grading B of AASHTO M147-65 (1990) as per MASH. For post numbers 3 through 27, 152-millimeters wide x 305 millimeters deep x 362 millimeters long (6-inch x 12-inch x 14.25-inch) wood spacer blockouts were used to block the rail away from the front face of the steel posts. Standard 2.66 millimeters (12-gauge) thick W-beam rails with additional post bolt slots at half post spacing intervals were placed between post numbers 1 and 29. The following test vehicles were used at indicated guardrail heights:

1. Test Vehicle 1100C: The W-beam's top rail height of 813 millimeters (32 inches) with a 657 millimeters (25 7/8-inch) center mounting height.
2. Test Vehicle 2270P: The W-beam's top rail height was 787 millimeters (31 inches) with a 632 millimeters (24 7/8 inches) center mounting height.

The rail splices have been moved to the center of the span location. All lap-splice connections between the rail sections were configured to reduce vehicle snag at the splice during the crash test. Design details are provided as enclosure to this correspondence.

### **Crash Testing**

Physical crash test for Test Level 3 as per MASH requires that longitudinal barrier systems be subjected to the following two full-scale vehicle crash tests:

1. Test Designation 3-10. A 1,100-kg (2,425-lb.) small car impacting the W-beam system at a nominal speed and angle of 100 km/h (62.1 mph) and 25 degrees, respectively.
2. Test Designation 3-11. A 2,268-kg (5,000-lb.) pickup truck impacting the W-beam system at a nominal speed and angle of 100 km/h (62.1 mph) and 25 degrees, respectively.

### **Findings**

The MGS strong-post W-beam guardrail system was constructed and crash tested. Full-scale vehicle crash tests using a 1100C small car vehicle and a 2270P pickup truck vehicle were performed and was determined to be acceptable according to the TL-3 safety performance criteria presented in MASH. All physical crash test summaries are included as enclosure to this correspondence.

Therefore, the system described in the requests above and detailed in the enclosed drawings is acceptable for use on the NHS under the range of conditions tested, when such use is acceptable to a highway agency.

Please note the following standard provisions that apply to FHWA letters of acceptance:

- This acceptance provides a AASHTO/ARTBA/AGC Task Force 13 designator that should be used for the purpose of the creation of a new and/or the update of existing Task Force 13 drawing for posting on the on-line 'Guide to Standardized Highway Barrier Hardware' currently referenced in AASHTO 'Roadside Design Guide'.
- This acceptance is limited to the crashworthiness characteristics of the systems and does not cover their structural features, nor conformity with the Manual on Uniform Traffic Control Devices.
- Any changes that may adversely influence the crashworthiness of the system will require a new acceptance letter.
- Should the FHWA discover that the qualification testing was flawed, that in-service performance reveals unacceptable safety problems, or that the system being marketed is significantly different from the version that was crash tested, we reserve the right to modify or revoke our acceptance.
- You will be expected to supply potential users with sufficient information on design and installation requirements to ensure proper performance.
- You will be expected to certify to potential users that the hardware furnished has essentially the same chemistry, mechanical properties, and geometry as that submitted for acceptance, and that it will meet the crashworthiness requirements of the FHWA and the AASHTO MASH.
- To prevent misunderstanding by others, this letter of acceptance is designated as number B-212 and shall not be reproduced except in full. This letter and the test documentation upon which it is based are public information. All such letters and documentation may be reviewed at our office upon request.
- This acceptance letter shall not be construed as authorization or consent by the FHWA to use, manufacture, or sell any patented system for which the applicant is not the patent holder. The acceptance letter is limited to the crashworthiness characteristics of the candidate system, and the FHWA is neither prepared nor required to become involved in issues concerning patent law. Patent issues, if any, are to be resolved by the applicant.

Sincerely yours,

Michael S. Griffith  
Director, Office of Safety Technologies  
Office of Safety

Enclosures



June 10, 2011

In Reply Refer To:  
HSST/B-212

Ms. Karla A. Lechtenberg, MSME, EIT  
Research Associate Engineer  
Midwest Roadside Safety Facility  
130 Whittier Research Center  
2200 Vine Street  
Lincoln, NE 68583-0853

Dear Ms. Lechtenberg:

This letter is in response to your request for the Federal Highway Administration (FHWA) acceptance of a roadside safety system for use on the National Highway System (NHS).

Name of system: Midwest Guardrail System  
Type of system: Steel Post and W-beam roadside barrier  
Test Level: AASHTO Manual for Assessing Safety Hardware  
Test Level 3  
Testing conducted by: Midwest Roadside Safety Facility  
Date of request: December 18, 2010  
Date initially acknowledged: December 18, 2010  
Task Force 13 Designator: SGR20 a-b

You requested that we find this system acceptable for use on the NHS under the provisions of the American Association of State Highway and Transportation Officials (AASHTO) "Manual for Assessing Safety Hardware" (MASH).

### **Requirements**

Roadside safety devices should meet the guidelines contained in the MASH.

### **Decision**

The following device was found acceptable, with details provided below:

- Midwest Longitudinal Guardrail System (MGS)

### **Description**

The test installation consisted of 55.25 meters (181 feet 3 inches) of standard 2.66 millimeters (12-gauge) thick W-beam guardrail supported by steel posts. Anchorage systems similar to those used on tangent guardrail terminals were utilized on both the upstream and downstream ends of



the guardrail system. The entire system was constructed with twenty-nine guardrail posts. Post numbers 3 through 27 were galvanized ASTM A36 steel W152 x 13.4 (W6 x 9) sections measuring 1,829 millimeters (6 feet) long. Post numbers 1, 2, 28, and 29 were timber posts measuring 140 millimeters wide x 190 mm deep x 1,080 millimeters long (5.5-inch x 7.5-inch x 42.5-inch) and were placed in 1,829 millimeters (6 feet) long steel foundation tubes. The timber posts and foundation tubes were part of anchor systems designed to replicate the capacity of a tangent guardrail terminal. Post numbers 1 through 29 were spaced 1,905 millimeters (75 inches) on center with a soil embedment depth of 1,016 millimeters (40 inches). The posts were placed in a compacted coarse, crushed limestone material that met Grading B of AASHTO M147-65 (1990) as per MASH. For post numbers 3 through 27, 152-millimeters wide x 305 millimeters deep x 362 millimeters long (6-inch x 12-inch x 14.25-inch) wood spacer blockouts were used to block the rail away from the front face of the steel posts. Standard 2.66 millimeters (12-gauge) thick W-beam rails with additional post bolt slots at half post spacing intervals were placed between post numbers 1 and 29. The following test vehicles were used at indicated guardrail heights:

1. Test Vehicle 1100C: The W-beam's top rail height of 813 millimeters (32 inches) with a 657 millimeters (25 7/8-inch) center mounting height.
2. Test Vehicle 2270P: The W-beam's top rail height was 787 millimeters (31 inches) with a 632 millimeters (24 7/8 inches) center mounting height.

The rail splices have been moved to the center of the span location. All lap-splice connections between the rail sections were configured to reduce vehicle snag at the splice during the crash test. Design details are provided as enclosure to this correspondence.

### **Crash Testing**

Physical crash test for Test Level 3 as per MASH requires that longitudinal barrier systems be subjected to the following two full-scale vehicle crash tests:

1. Test Designation 3-10. A 1,100-kg (2,425-lb.) small car impacting the W-beam system at a nominal speed and angle of 100 km/h (62.1 mph) and 25 degrees, respectively.
2. Test Designation 3-11. A 2,268-kg (5,000-lb.) pickup truck impacting the W-beam system at a nominal speed and angle of 100 km/h (62.1 mph) and 25 degrees, respectively.

### **Findings**

The MGS strong-post W-beam guardrail system was constructed and crash tested. Full-scale vehicle crash tests using a 1100C small car vehicle and a 2270P pickup truck vehicle were performed and was determined to be acceptable according to the TL-3 safety performance criteria presented in MASH. All physical crash test summaries are included as enclosure to this correspondence.

Therefore, the system described in the requests above and detailed in the enclosed drawings is acceptable for use on the NHS under the range of conditions tested, when such use is acceptable to a highway agency.

Please note the following standard provisions that apply to FHWA letters of acceptance:

- This acceptance provides a AASHTO/ARTBA/AGC Task Force 13 designator that should be used for the purpose of the creation of a new and/or the update of existing Task Force 13 drawing for posting on the on-line 'Guide to Standardized Highway Barrier Hardware' currently referenced in AASHTO 'Roadside Design Guide'.
- This acceptance is limited to the crashworthiness characteristics of the systems and does not cover their structural features, nor conformity with the Manual on Uniform Traffic Control Devices.
- Any changes that may adversely influence the crashworthiness of the system will require a new acceptance letter.
- Should the FHWA discover that the qualification testing was flawed, that in-service performance reveals unacceptable safety problems, or that the system being marketed is significantly different from the version that was crash tested, we reserve the right to modify or revoke our acceptance.
- You will be expected to supply potential users with sufficient information on design and installation requirements to ensure proper performance.
- You will be expected to certify to potential users that the hardware furnished has essentially the same chemistry, mechanical properties, and geometry as that submitted for acceptance, and that it will meet the crashworthiness requirements of the FHWA and the AASHTO MASH.
- To prevent misunderstanding by others, this letter of acceptance is designated as number B-212 and shall not be reproduced except in full. This letter and the test documentation upon which it is based are public information. All such letters and documentation may be reviewed at our office upon request.
- This acceptance letter shall not be construed as authorization or consent by the FHWA to use, manufacture, or sell any patented system for which the applicant is not the patent holder. The acceptance letter is limited to the crashworthiness characteristics of the candidate system, and the FHWA is neither prepared nor required to become involved in issues concerning patent law. Patent issues, if any, are to be resolved by the applicant.

Sincerely yours,

A handwritten signature in blue ink that reads "Michael S. Griffith". The signature is written in a cursive style with a blue highlighter effect.

Michael S. Griffith  
Director, Office of Safety Technologies  
Office of Safety

Enclosures

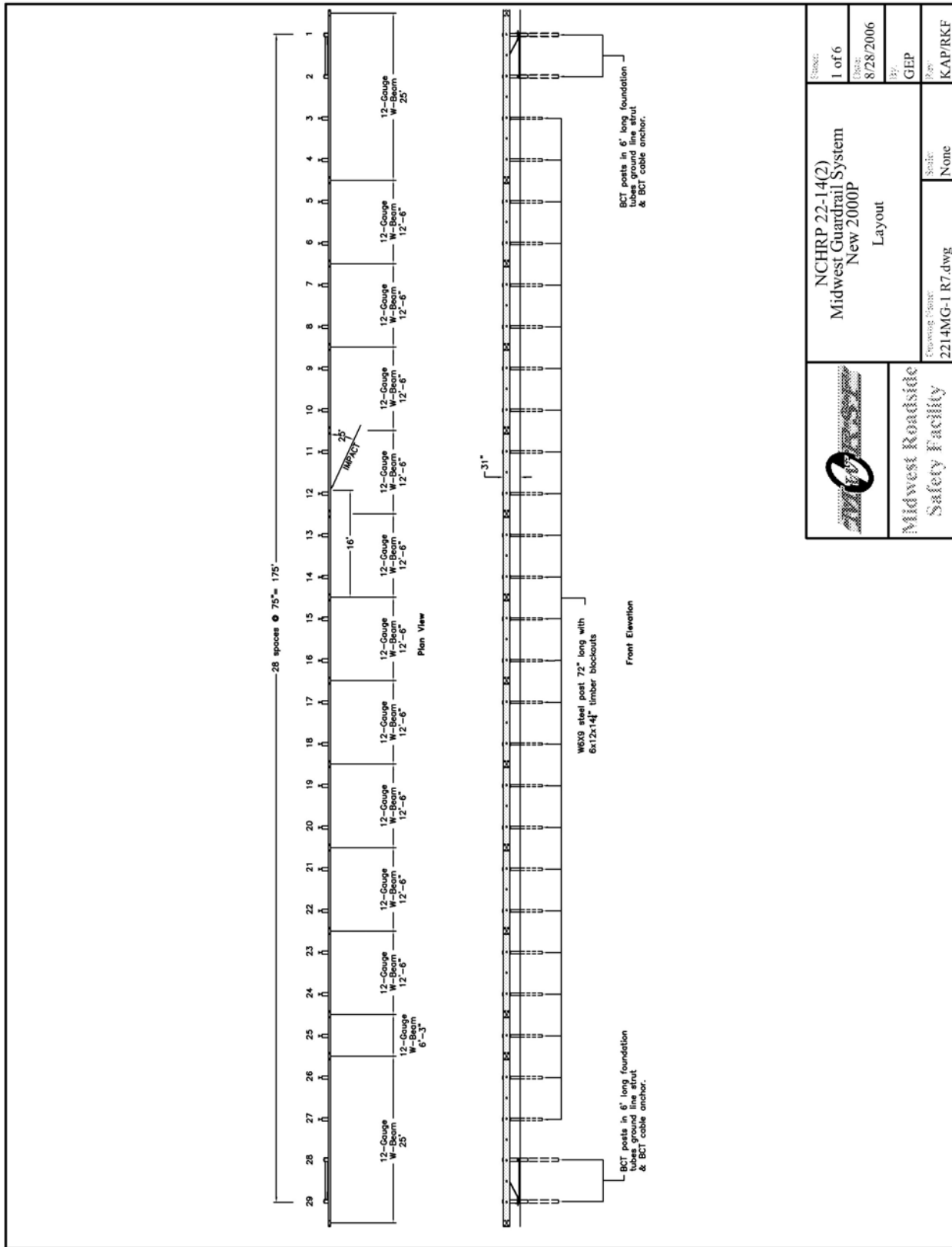
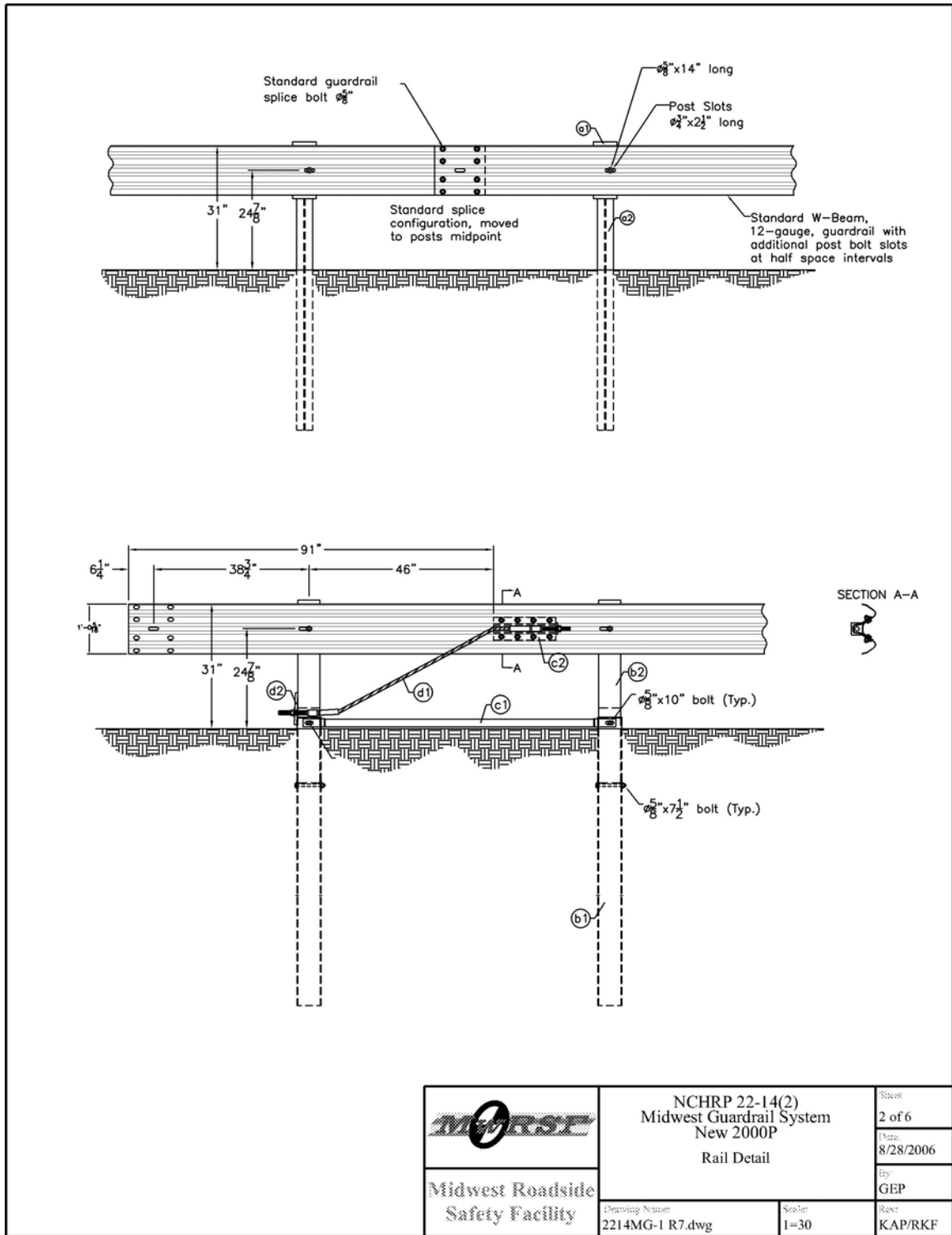

Figure A-1. Layout of Midwest Guardrail System Design (English)



	NCHRP 22-14(2) Midwest Guardrail System New 2000P Rail Detail		Sheet 2 of 6
			Date 8/28/2006
Midwest Roadside Safety Facility	Drawing Number 2214MG-1 R7.dwg	Section 1=30	Ety GEP Rev KAP/RKF

Figure A-2. Midwest Guardrail System Rail Details (English)



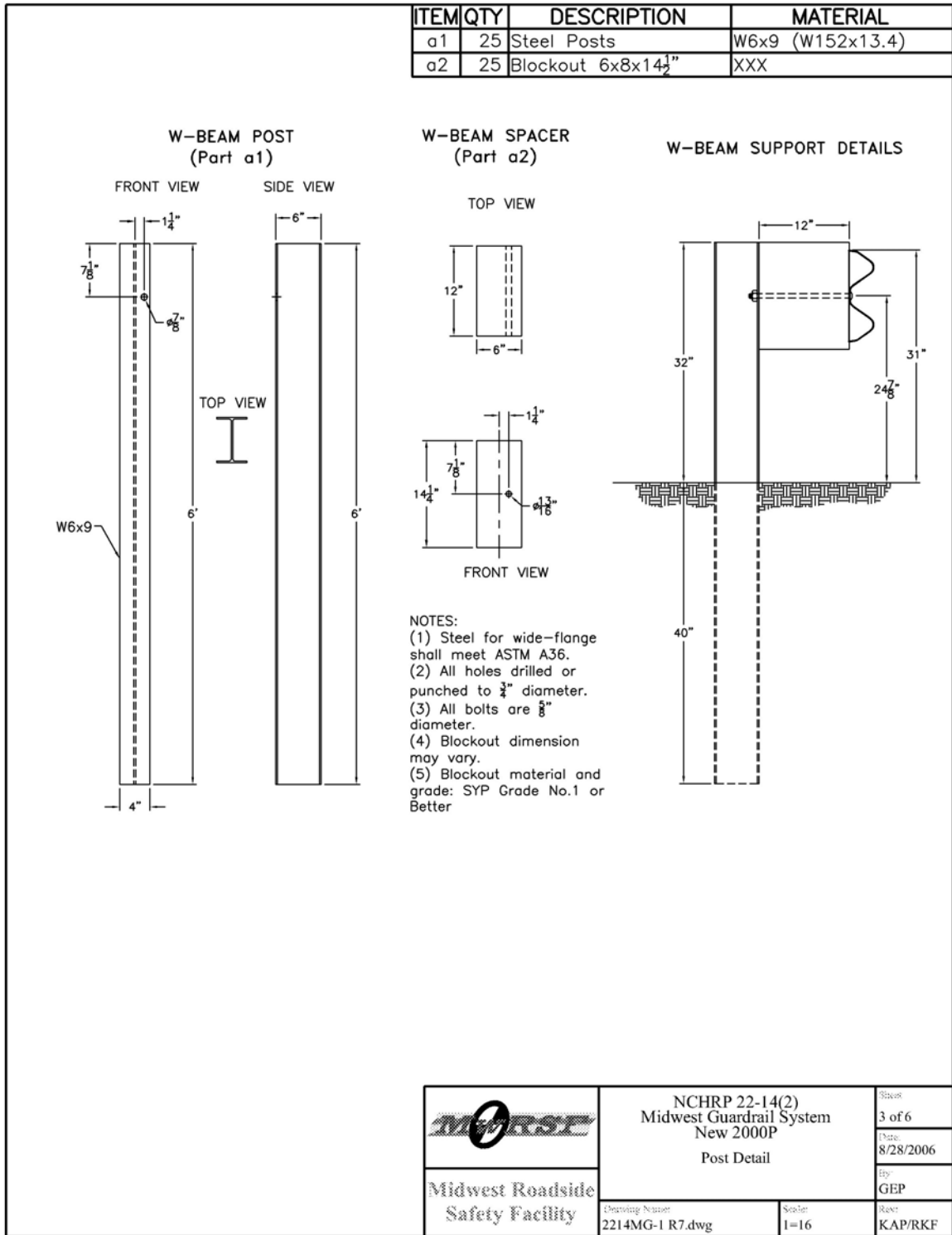

Figure A-3. Midwest Guardrail System Post Details (English)

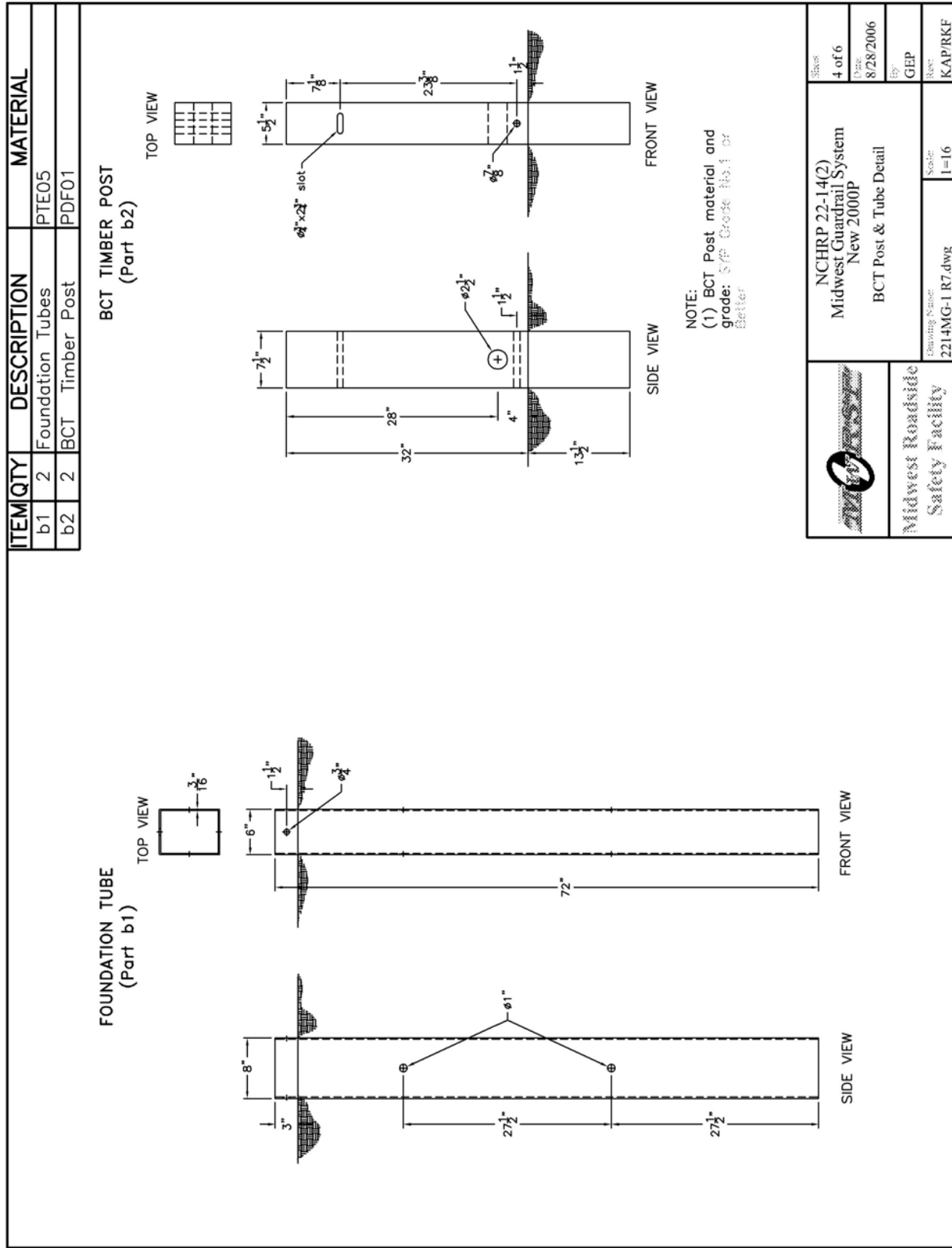

Figure A-4. Midwest Guardrail System Anchorage Details (English)

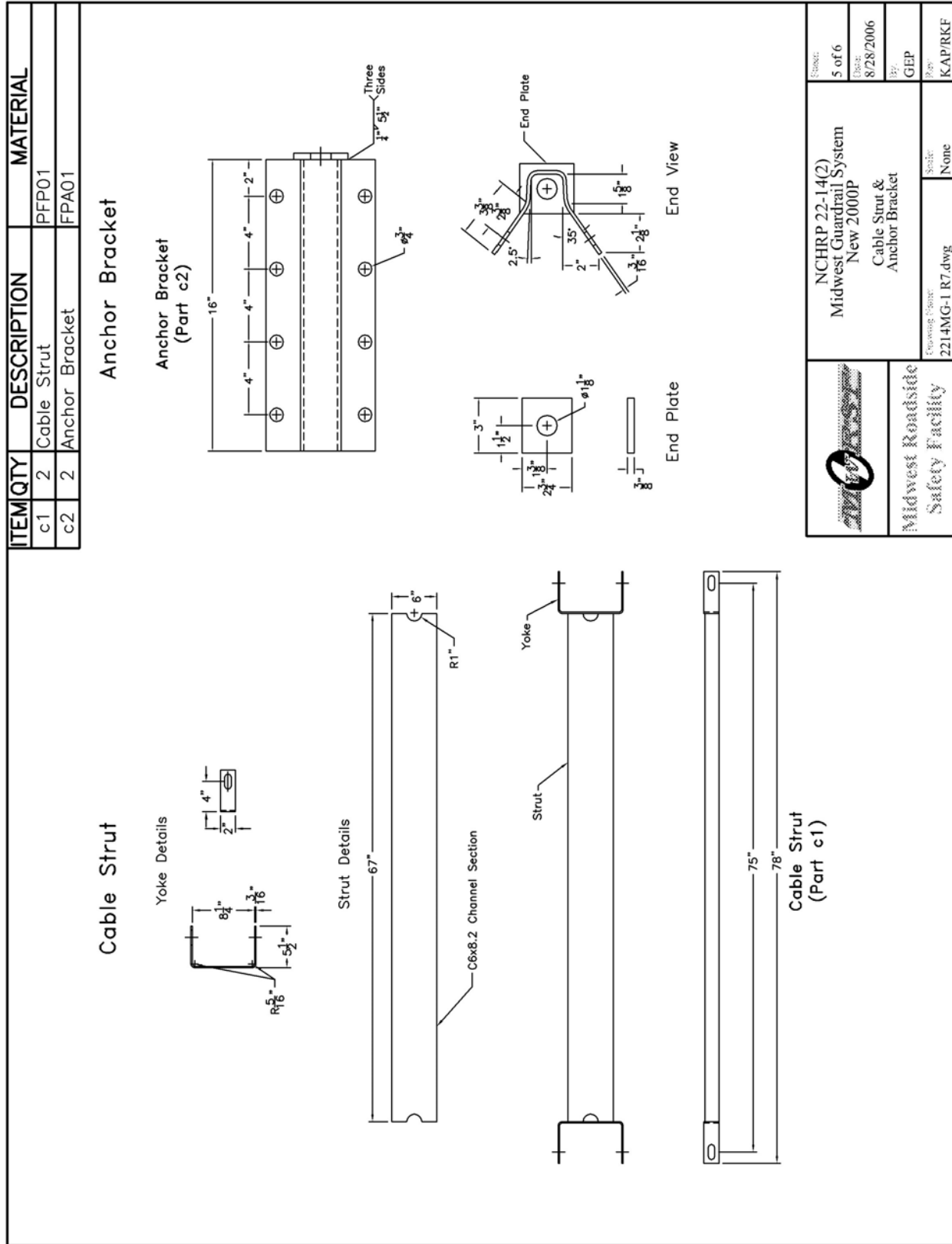

Figure A-5. Midwest Guardrail System Anchorage Details (English)

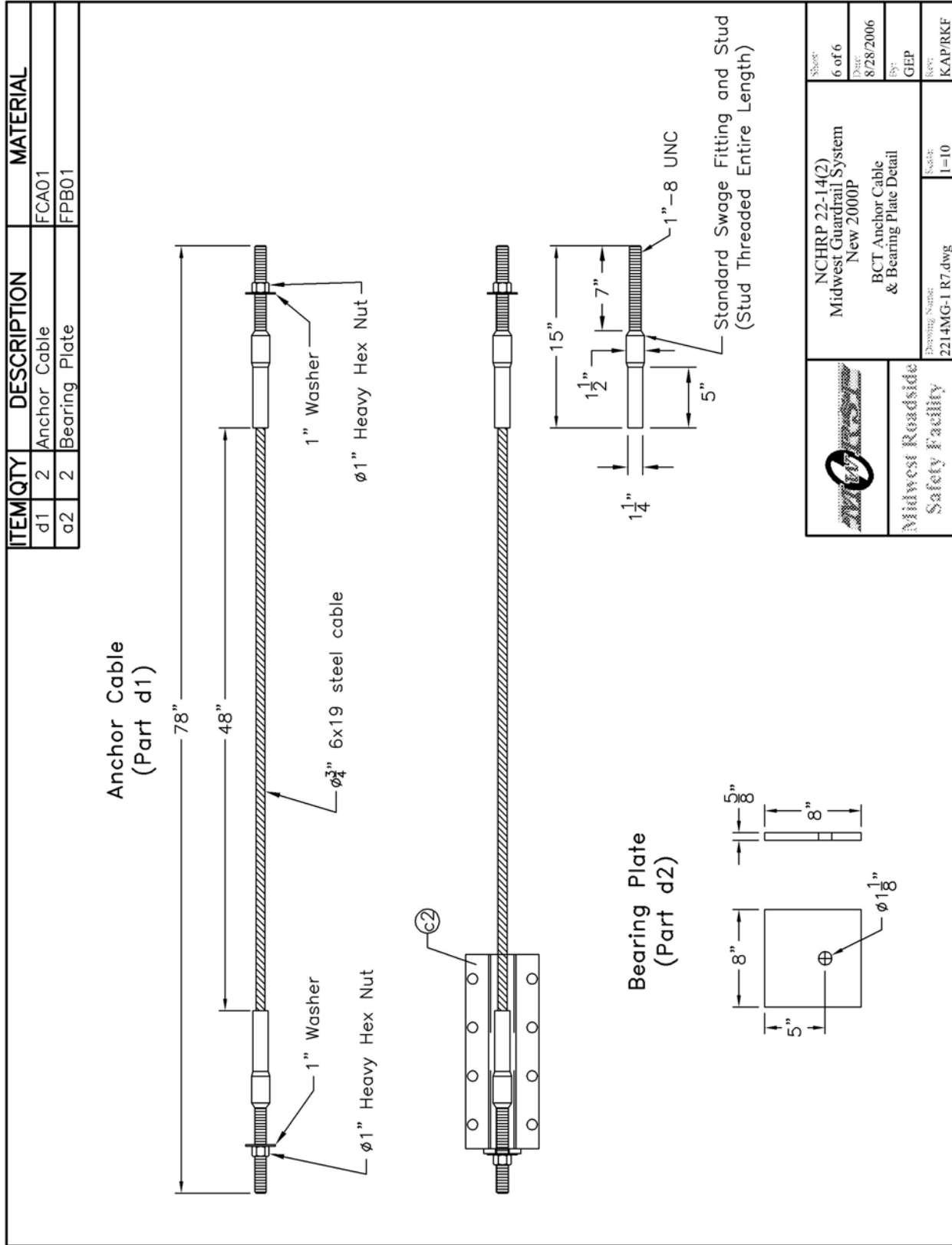
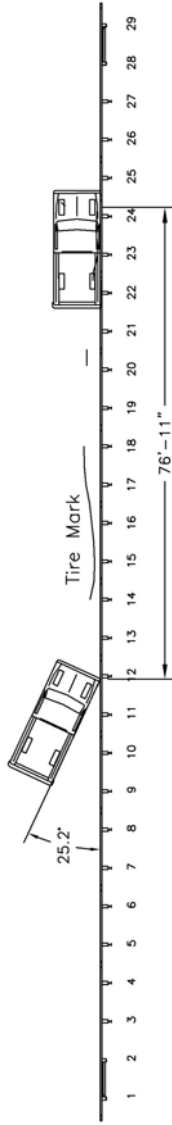

Figure A-6. Midwest Guardrail System Anchorage Details (English)



0.000 sec                      0.118 sec                      0.222 sec                      0.378 sec                      0.466 sec



- Test Agency ..... MwRSF
- Test Number ..... 2214MG-1
- Date ..... 5/7/04
- NCHRP 350 Update Test Designation .. 3-11
- Appearance ..... Midwest Guardrail System
- Total Length ..... 181 ft - 3 in.
- Key Elements - Steel W-Beam
  - Thickness ..... 12 gauge
  - Top Mounting Height ..... 31 in.
- Key Elements - Steel Posts
  - Post Nos. 3 - 27 ..... W6x9 by 6 ft long
  - Spacing ..... 75 in.
- Key Elements - Wood Posts
  - Post Nos. 1 - 2, 28 - 29 (BCT) ..... 5.5 in. x 7.5 in. by 42.5 in. long
- Key Elements - Steel Foundation Tube . 6-ft long
- Key Elements - Wood Spacer Blocks
  - Post Nos. 3 - 27 ..... 6 in. x 12 in. by 14.25 in. long
- Type of Soil ..... Grading B - AASHTO M 147-65 (1990)
- Test Vehicle
  - Type/Designation ..... 2270P
  - Make and Model ..... 2002 GMC 2500 ¾-ton Pickup
  - Curb ..... 4,700 lbs
  - Test Inertial ..... 5,000 lbs
  - Gross Static ..... 5,000 lbs
- Impact Conditions
  - Speed ..... 62.6 mph
  - Angle ..... 25.2 degrees
  - Impact Location ..... 15 ft - 10.5 in. upstream splice btwn posts 14 & 15
- Exit Conditions
  - Speed ..... 42.5 mph
  - Angle ..... Apprx. 7 degrees
  - Exit Box Criterion ..... Pass
- Post-Impact Trajectory
  - Vehicle Stability ..... Satisfactory
  - Stopping Distance ..... 76 ft - 11 in. downstream
  - Against traffic-side face
- Occupant Impact Velocity (350 Update)
  - Longitudinal ..... 17.06 ft/s < 39.4 ft/s
  - Lateral ..... 14.80 ft/s < 39.4 ft/s
- Occupant Ridedown Deceleration (350 Update)
  - Longitudinal ..... 8.77 Gs < 20 Gs
  - Lateral ..... 5.34 Gs < 20 Gs
- THIV (not required) ..... 23.52 ft/s
- PHD (not required) ..... 9.41 Gs
- Test Article Damage ..... Moderate
- Test Article Deflections
  - Permanent Set ..... 42.875 in.
  - Dynamic ..... 57.0 in.
  - Working Width ..... 57.3 in.
- Vehicle Damage ..... Moderate
  - VDS<sup>5</sup> ..... 1-RFQ-4
  - CDC<sup>6</sup> ..... 1-RYEN3
  - Maximum Deformation ..... 1 in. at right-center floorpan

Figure B-1. Summary of Test Results and Sequential Photographs (English), Test 2214MG-1